

PALIO TRADE

by Karndean

RIGID CORE LUXURY VINYL FLOORING

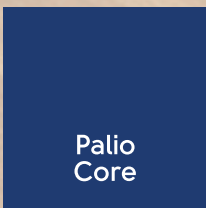

QUICK AND EASY
TO INSTALL



DURABLE



LOW
MAINTENANCE



WATERPROOF



COMPATIBLE WITH
UNDERFLOOR
HEATING



GENNA SM-RCP6550

CONTENTS

WHAT IS PALIO TRADE BY KARNDEAN?	4
INTRODUCING PALIO CORE	6
CHOOSING YOUR LAYING PATTERN	8
CHOOSE PALIO CORE WHEN	10
WOOD AT A GLANCE	12
STONE AT A GLANCE	13
WOOD COLLECTION	14
STONE COLLECTION	22
SCOTIA AND SKIRTING	26
INSTALLATION GUIDELINES	28
TECHNICAL SPECIFICATION	29
VISIT US ONLINE	30

WHAT IS PALIO TRADE BY KARNDEAN?

Palio Trade by Karndean luxury vinyl flooring is not like typical vinyl. It doesn't come in rolls or sheets, it comes in robust, pre-cut planks and tiles. Our highly realistic designs look just like the wood and stone materials they're inspired by and offer the following benefits:



QUICK AND EASY TO INSTALL
Using our click-locking mechanism.



HIGHLY REALISTIC DESIGNS
Designed by Karndean's in-house product team to perfectly replicate real wood and stone.



DURABLE
The natural appearance of wood and stone but the durability and resilience of luxury vinyl with a 20 year residential guarantee.



LOW MAINTENANCE
Clean easily with a sweep and mop.
No sanding, varnishing or staining.



WATERPROOF
Won't swell, crack or warp when wet.



SOFT, WARM AND QUIET UNDERFOOT
No cold tiles, no clicking shoes.



HYGIENIC
Unlike carpets, our floors don't hold dust, dirt, pollen or other allergens.



COMPATIBLE WITH UNDERFLOOR HEATING
Up to 27°C.



DOMASO RCP6532

Palio
Core







INTRODUCING PALIO CORE

Palio Core combines our simple 2G™ click-locking mechanism with a rigid core construction which provides more stability on uneven subfloors. With its acoustic foam backing, it can reduce noise transfer to rooms below by up to 19dB and there is no need for additional underlay.



SORANO RCP6508

WHY PALIO CORE?

-  QUICK AND EASY TO INSTALL
-  PATENTED CLICK-LOCKING MECHANISM
-  NO UNDERLAY REQUIRED
-  INSTALLS OVER MOST EXISTING HARD FLOORS
-  REDUCES IMPACT NOISE TRANSFER BY 19dB
-  RIGID CORE CONSTRUCTION



HERRINGBONE

Three of the Palio Core designs are available in both large and small planks. The smaller planks 596mm x 149mm, are laid in a modern herringbone design to create an extra sense of style. Look out for our herringbone icon.

PALIO CORE COMPOSITION

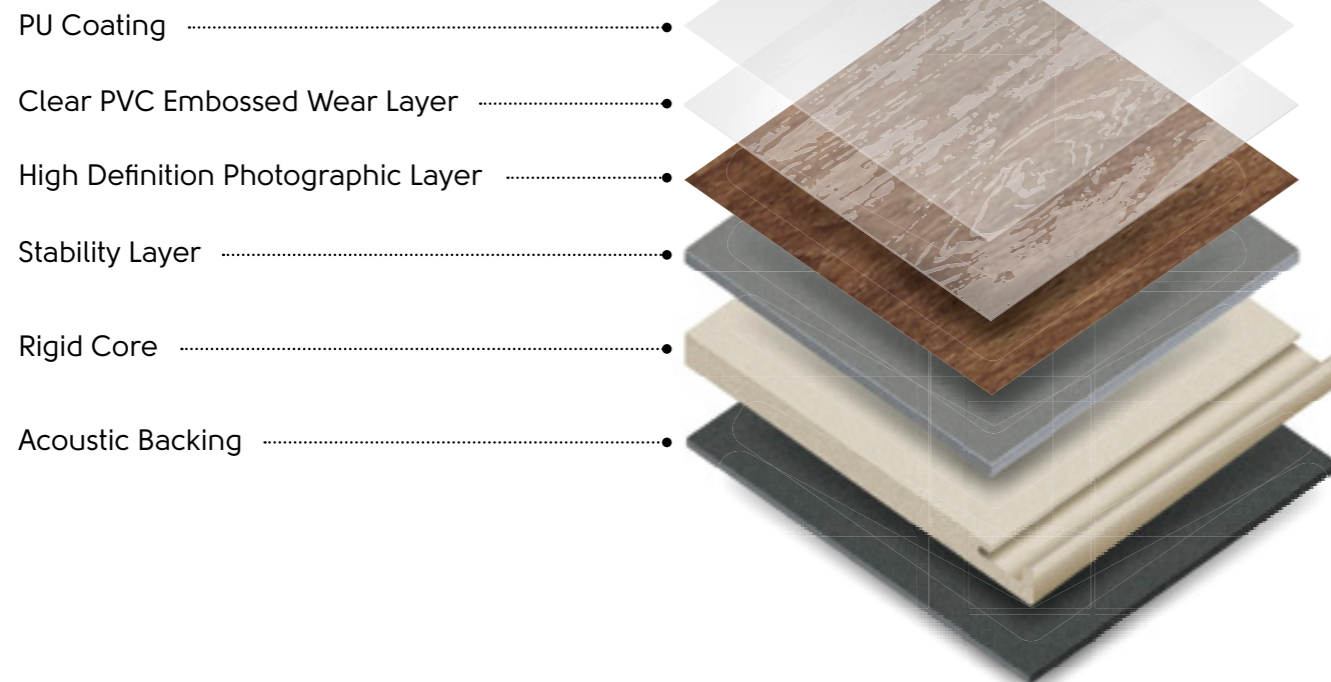

GENNA SM-RCP6550

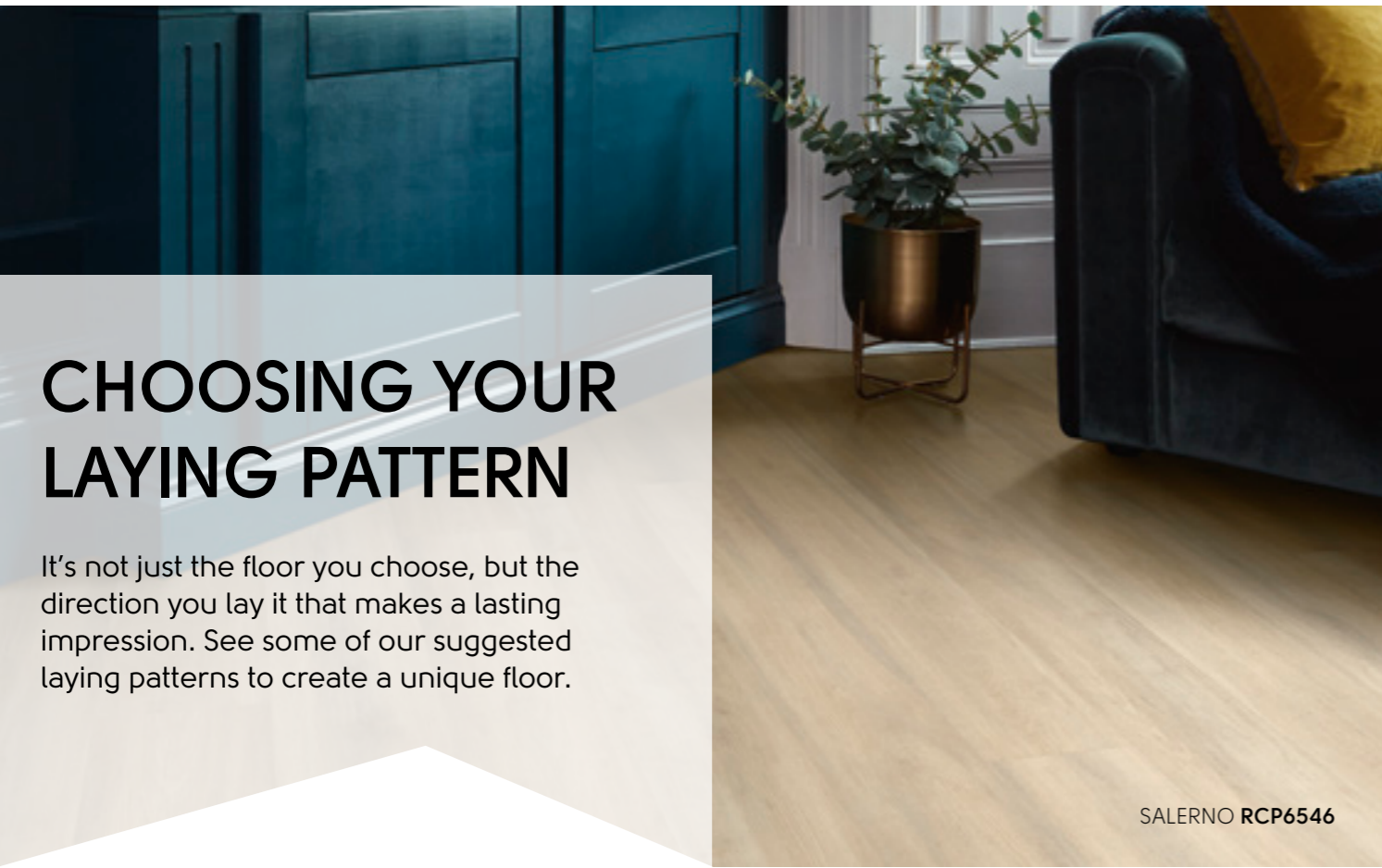

CHOOSING YOUR LAYING PATTERN

It's not just the floor you choose, but the direction you lay it that makes a lasting impression. See some of our suggested laying patterns to create a unique floor.

SALERNO RCP6546

HERRINGBONE

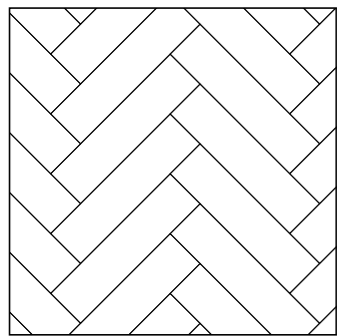

Herringbone

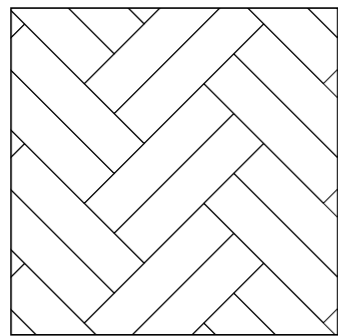

Double herringbone

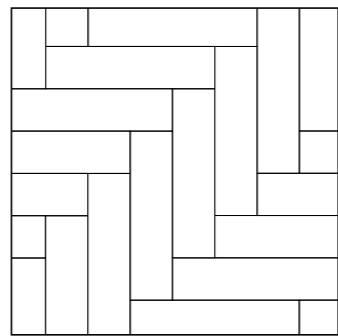

90 degree herringbone

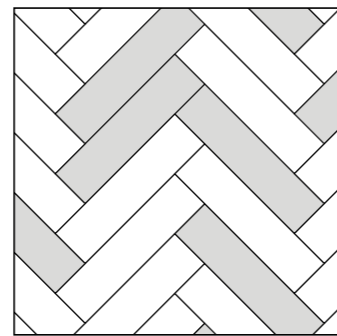

Herringbone mixed designs



MODENA SM-RCP6533

MIXED PATTERNS

Using a suitable threshold strip between different laying patterns means you can create room to room designs.

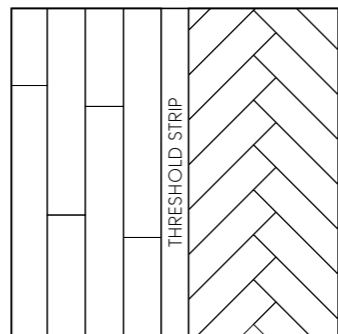

Staggered with herringbone

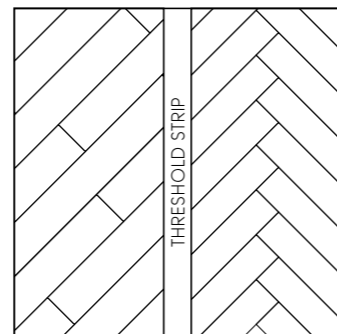

Diagonal with herringbone

WOOD

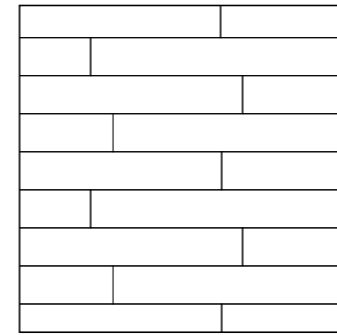

Staggered

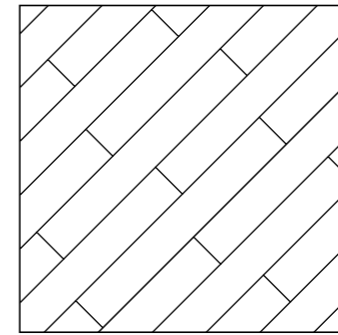

Diagonal

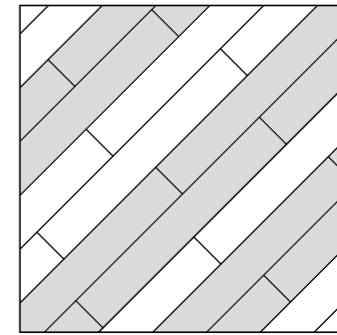

Striped (2-designs)

STONE

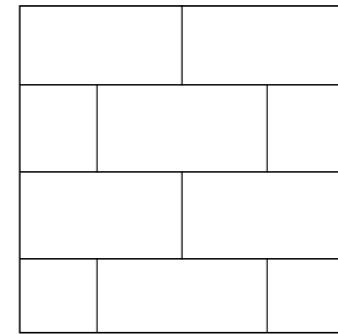

Brick Lay

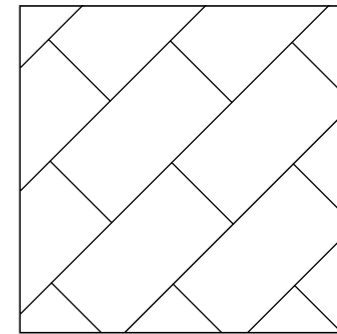

Diagonal

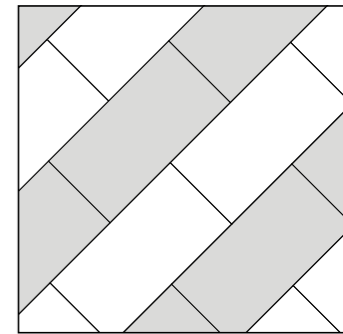





Striped (2-designs)



CARINI RCT6307

CHOOSE PALIO CORE WHEN...

-  You would like a 100% waterproof floor.
-  You need superior acoustics between floors.
-  Your floor is still drying out such as new build developments.
-  You are working on a building with structural limitations or preservation requirements.



You need a quick, simple installation with minimal downtime.



AREZZO RCP6503



You need to install over an existing hard floor.

MODENA SM-RCP6533



You would like to fit underfloor heating.

ANDRIA RCP6544

WOOD AT A GLANCE



ANDRIA

RCP6544

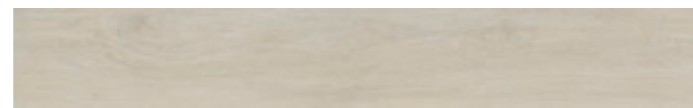

SORANO

RCP6508



SALERNO

RCP6546



BARLETTA

RCP6549



MONZA

RCP6551



AREZZO

RCP6503



GALLINA

RCP6547



MONTIERI

RCP6504



GENNA

RCP6550



MODENA

RCP6533



DOMASO

RCP6532



BOLSENA

RCP6507



LUCCA

RCP6509

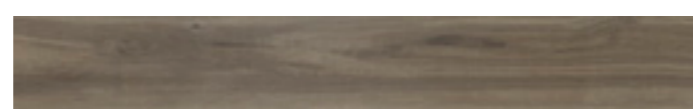

SCOPETI

RCP6548



BARLETTA RCP6549

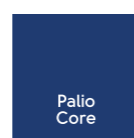

Size: 1220mm x 179mm
Thickness: 6.5mm
Wear Layer: 0.55mm
Box Quantity: 2.184m²

WOOD HERRINGBONE AT A GLANCE



MODENA

SM-RCP6533



GENNA

SM-RCP6550



MONZA

SM-RCP6551

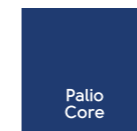

Size: 596mm x 149mm
Thickness: 6.5mm

Wear Layer: 0.55mm
Box Quantity: 1.954m²



GENNA SM-RCP6550

STONE AT A GLANCE



MASSA

RCT6306

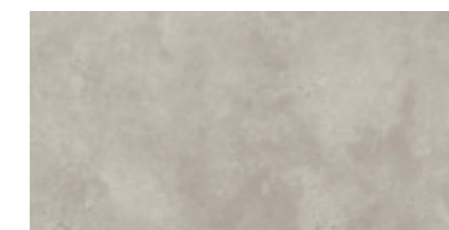

CARINI

RCT6307

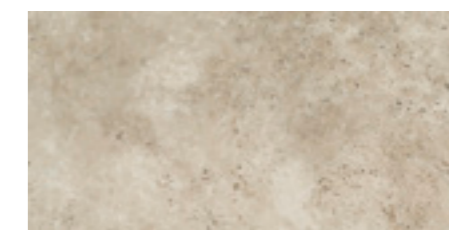

PIENZA

RCT6303

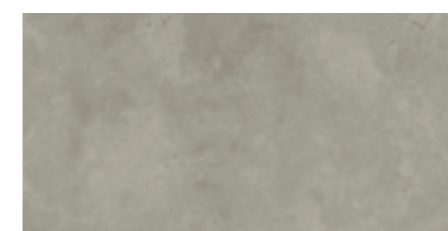

CATANIA

RCT6308

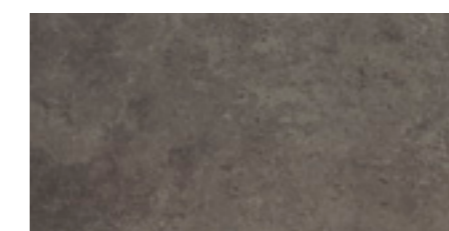

CETONA

RCT6304

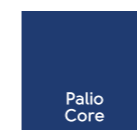

Size: 307mm x 600mm
Thickness: 6.5mm

Wear Layer: 0.55mm
Box Quantity: 1.842m²



MASSA RCT6306



Palio floors are naturally warmer than wood or stone but are also compatible with underfloor heating up to 27°C.



MONZA SM-RCP6551

WOOD HERRINGBONE

596mm x 149mm

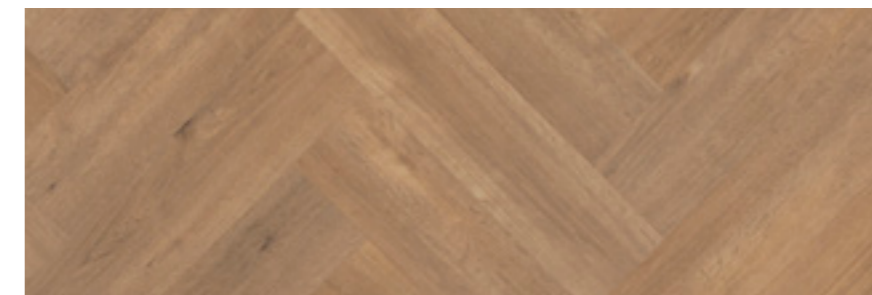

MODENA SM-RCP6533

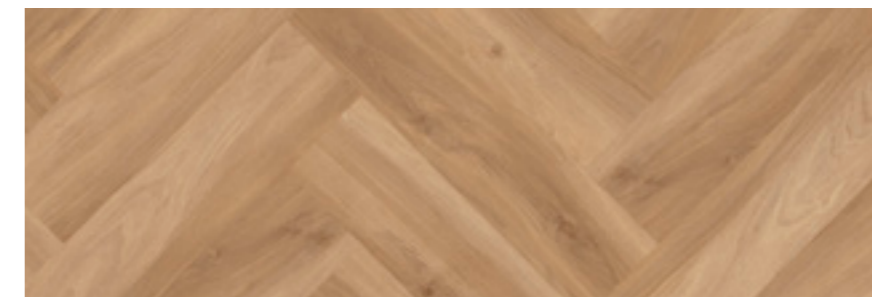

GENNA SM-RCP6550

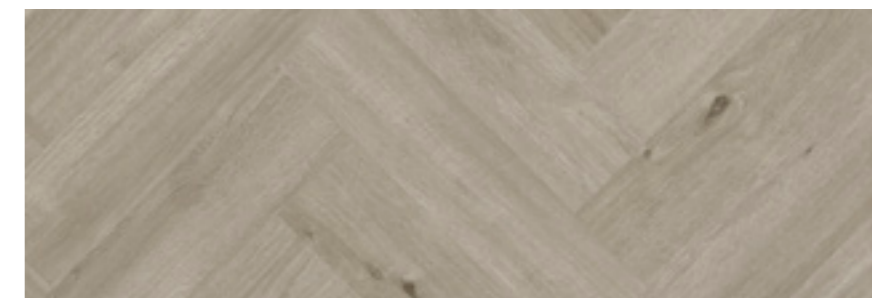

MONZA SM-RCP6551



MODENA SM-RCP6533

WOOD

1220mm x 179mm



ANDRIA RCP6544

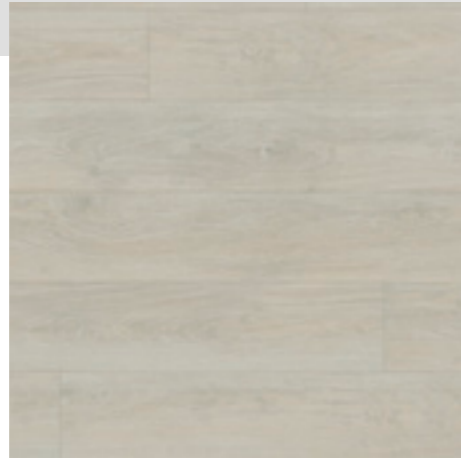

SORANO RCP6508

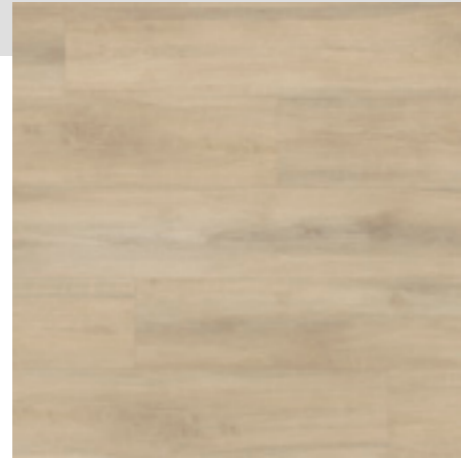

SALERNO RCP6546



MONZA RCP6551



Click-locking planks or tiles together enables a quick and easy installation.



SALERNO RCP6546

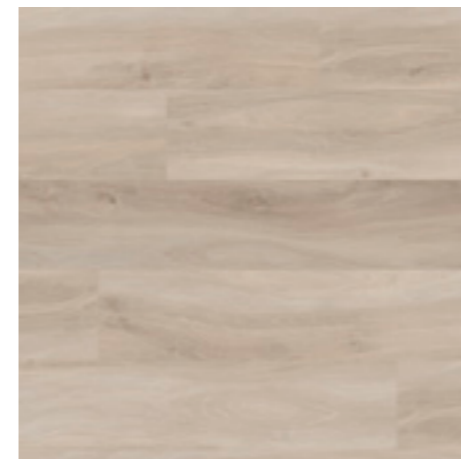

BARLETTA RCP6549



MONZA RCP6551



AREZZO RCP6503

WOOD

1220mm x 179mm



GALLINA RCP6547

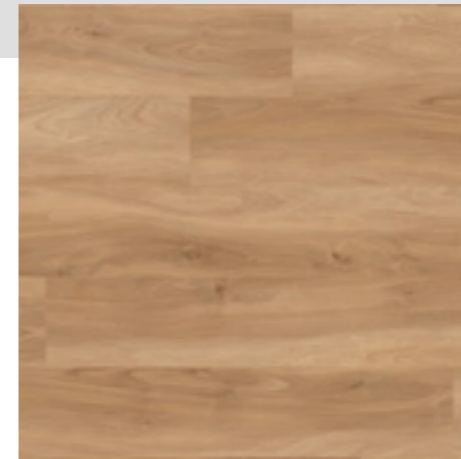

GENNA RCP6550

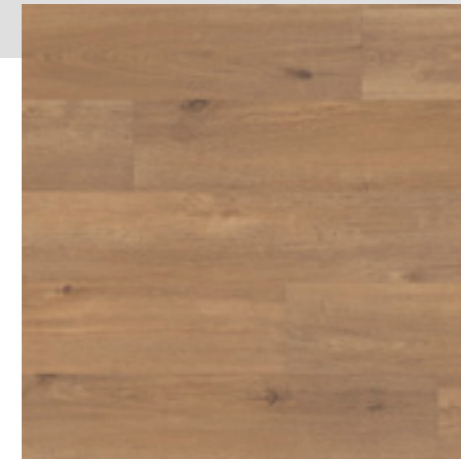

MODENA RCP6533



DOMASO RCP6532



MONTIERI RCP6504



GALLINA RCP6547



MONTIERI RCP6504



MODENA RCP6533



100% waterproof makes any Palio floor an ideal solution for bathrooms and kitchens.



BOLSENA RCP6507

WOOD

1220mm x 179mm



BOLSENA RCP6507



LUCCA RCP6509



SCOPETI RCP6548

STONE

307mm x 600mm

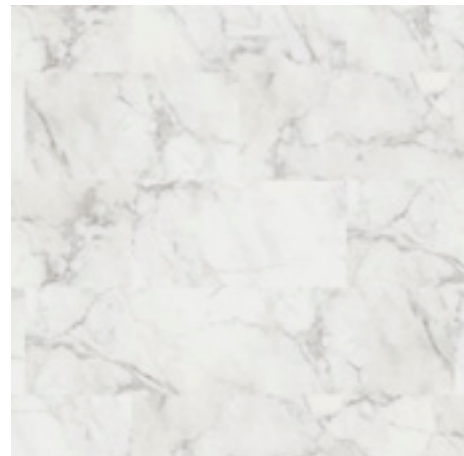

MASSA RCT6306



CATANIA RCT6308



CETONA RCT6304



MASSA RCT6306



CARINI RCT6307

STONE

307mm x 600mm



CARINI RCT6307



PIENZA RCT6303



PIENZA RCT6303

100% WATERPROOF SCOTIA AND SKIRTING

The light weight, flexible colour matched scotia helps finish the installation and hides your expansion gap.

AREZZO	SCO-RCP6503	
MONTIERI	SCO-RCP6504	
BOLSENA	SCO-RCP6507	
SORANO	SCO-RCP6508	
LUCCA	SCO-RCP6509	
DOMASO	SCO-RCP6532	
MODENA	SCO-RCP6533	
ANDRIA	SCO-RCP6544	
SALERNO	SCO-RCP6546	
GALLINA	SCO-RCP6547	
SCOPETI	SCO-RCP6548	
BARLETTA	SCO-RCP6549	
GENNA	SCO-RCP6550	
MONZA	SCO-RCP6551	
PIENZA	SCO-RCT6303	
CETONA	SCO-RCT6304	
MASSA	SCO-RCT6306	
CARINI	SCO-RCT6307	
CATANIA	SCO-RCT6308	
WHITE	SCO-WHITE	

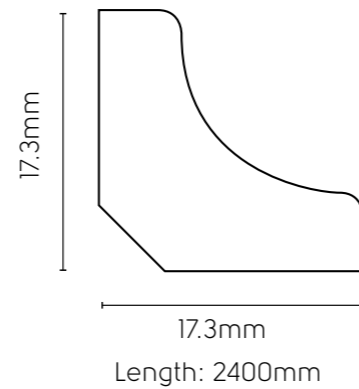

Alternatively finish with a new paintable white skirting board to hide the expansion gap between the wall and the floor.

WHITE	SK100-WHITE	
-------	-------------	---

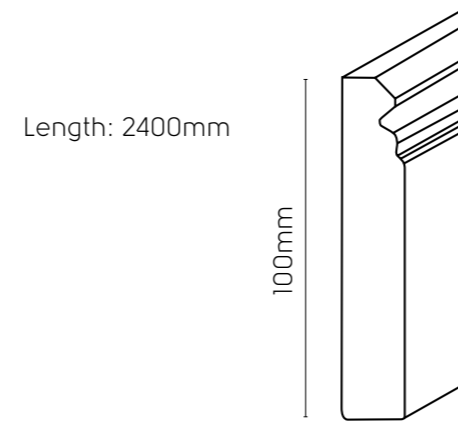

SCOTIA AND SKIRTING INSTALLATION GUIDELINES

For full instructions and guidance on cutting scotia and skirting visit palioflooring.com

Joining straight lengths

Using a mitre block, cut the left hand piece at a 45 degree angle and for the right hand piece use the same 45 degree angle as the left hand piece and make the cut.

Scotia

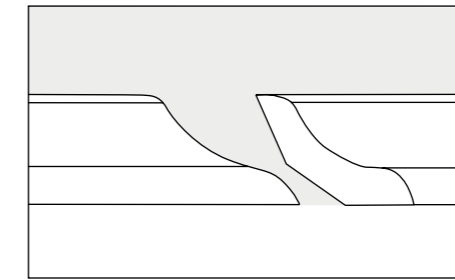

Skirting

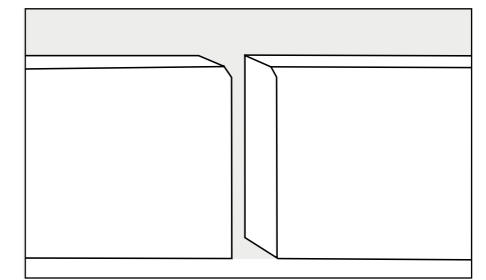

Internal corners

Using a mitre block, cut the left hand piece at 45 degrees sawing bottom left to top right. Cut the right hand piece at 45 degrees sawing bottom right to top left.

Scotia

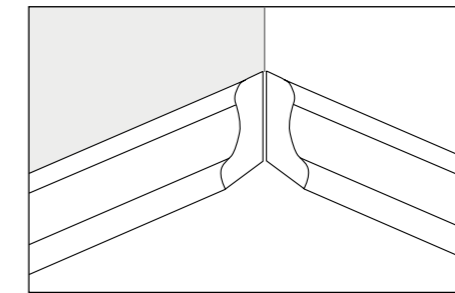

Skirting

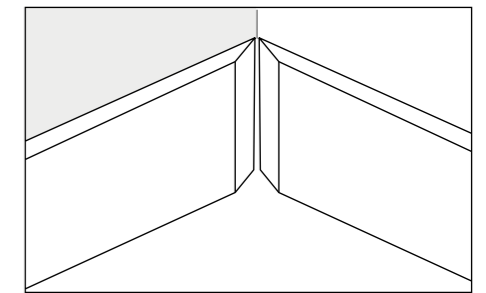

External corners

Using a mitre block, cut the left hand piece at 45 degrees sawing bottom right to top left. For the right hand piece, cut at 45 degrees sawing bottom left to top right.

Scotia

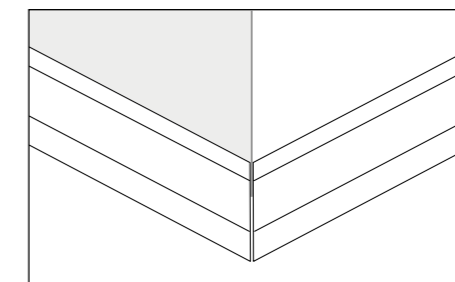

Skirting

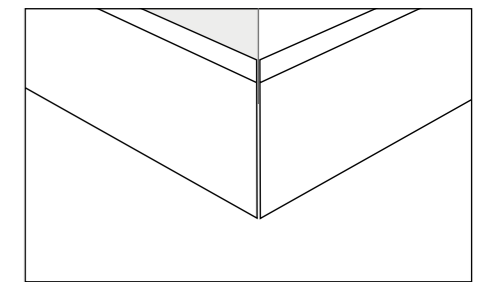

Scotia

Apply cartridge/tube adhesive to the back of your scotia and affix to the wall/skirting.

Use finishing nails every 450mm into the skirting.

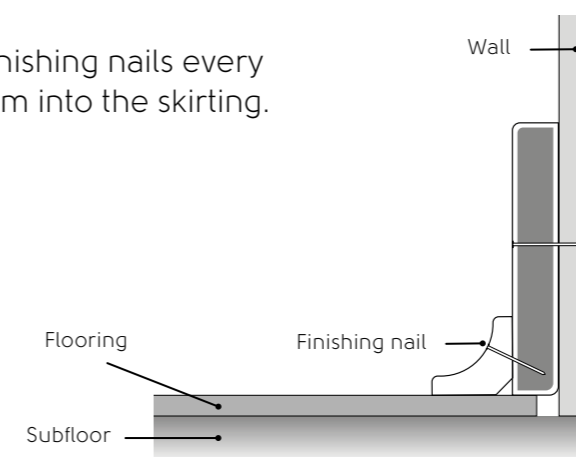

Skirting

Apply cartridge/tube adhesive to the back of the skirting and firmly press against the wall until cured. If required, use 18 gauge fine wire nails every 450mm through the skirting into the wall.

